

Quasi-steady Self-excited Angular Oscillation of Equilateral Triangular Cylinder in 2-D Separated Flow

Sutthiphong Srigrarom, Ph.D.

Assistant Professor

*Nanyang Technological University, School of Mechanical and Aerospace Engineering,
50, Nanyang Avenue, Singapore, 639798, e-mail: mssrigrarom@ntu.edu.sg*

Abstract

This paper studies the characteristics and the development of a particular fluid-structure interaction phenomenon –the continuous quasi-steady angular oscillation of a center-pivoted equilateral triangular cylinder, under the separated flow. We propose the explanation of this oscillation. Preliminary analysis indicates that the cylinder could oscillate incessantly in angular direction by initial positional perturbation or incoming flow fluctuation. It is the unbalance force acting on the cylinder's side faces that causes such movement. On one side, the flow will be flow-past-flat-plate like, whereas the other side will be flow-past-sharp-edge like. Due to the unbalanced pressure exerting on the two sides, the cylinder rotates. When the cylinder moves, these mechanisms switch side interchangeably, and bring the cylinder to continuous oscillation.

Initial dye flow visualization experiments of 30 cm long and 10 cm wide cylinder in the two-dimensional water tunnel were conducted. Under the uniform incoming flow of 5 cm/s, it is found that, after initial perturbation, the cylinder oscillated continuously, with angular amplitude of upto ± 30 degrees. On the windward side of the cylinder, a vortex was formed at the sharp edges of the cylinder during the initial phase, whereas on the leeward side, the flow stayed attached. The size of the separated vortex increased with the inlet velocity. Toward the rear of the cylinder on the leeward side, the sharp edge behind the cylinder created another vortex –of the opposite sign to the windward one, and caused reverse flow. Behind the cylinder, the pair of windward and leeward vortices interacted each other and were shed downstream by the main flow. The shedding pattern was, however, different from the common circular cylinder case.

Together with flow visualization, we recorded the hydrodynamic force and moment acting on this cylinder. We found the dominant oscillating frequency is about 0.1 Hz. The corresponding Strouhal number fell within limited range of $0.13 < Str < 0.18$. Beyond this range, the cylinder was either stationary or rotates only in one direction. We also conducted Particle Image Velocimetry to map and study the flow field details. The velocity and vorticity fields obtained appeared to agree with the proposed physical explanation of the phenomena.

Keyword: fluid-structure interaction, quasi-steady oscillation, triangular cylinder, 2D separated flow, vortex shedding, Strouhal number, PIV measurement

Introduction

Oscillating flaps or duck-fins are commonly used to suppress the ocean surface waves approaching the shore. The flaps or duck-fins have the drawback that it works only on the water surface. Recent studies (Nakashima, 1992) revealed that if an isosceles triangular wedge is placed in an otherwise uniform flow, it can be induced to oscillate incessantly. The equilateral triangular wedge is more effective than the flap or duck-fin, since, it can also function when submerged in the water. One can also extract energy from the oscillating and/or spinning motion of the wedge when it is under the influence of incoming flow or wave. The detailed motion of the wedge is, however, not fully understood. This is due to the unsteady surrounding flow, as well as, continuously moving boundary (the wedge either oscillates or rotates). This coupled fluid-structure interaction was first noticed by Nakashima et al (Nakashima, 1992) and it has not yet been well studied. Previous research only dealt with the stationary wedge at different position or oscillation in translational mode (Luo et al, 1993), or with other geometry (Naudascher & Wang, 1993, Nakamura & Nakashima, 1993, Sakamoto et al, 2001 and Hu et al, 2002).

Previous experiments (Srigrarom, 1998) investigated such behaviour by means of dye and Laser Induced Fluorescence flow visualization. For Strouhal number in the range $0.13 < St < 0.18$, the cylinder oscillates continuously. Beyond this range, the cylinder either remains stationary or rotates only in one direction.

In this paper, we present our observation. The continuous oscillation of the wedge is sustained by the symmetrical flow structure. On one side, the flow will be flow-past-flat-plate like, whereas the other side will be flow-past-sharp-edge like. When the wedge rotates, these mechanisms switch side

interchangeably, causing the wedge to oscillate continuously. The observation is supported by dye flow visualization images and Particle Image Velocimetry (PIV) measurements.

Proposed oscillation model

The explanation of the self-excited oscillation behaviour was elaborately discussed in Srigrarom, 2003. The key features are excerpted here. Consider the flow pattern around a symmetrical triangular cylinder rotating in the clockwise direction (Figure 1). The upstream flow is uniform at zero angle of attack, and is brought to stagnation at the front of the cylinder. The flow is divided into two (2) identical zones, upper and lower. The divided stream varies smoothly from a 90-degree turn at S to a stream merging with the free stream at edge A or B . At A or B , the flow separates from the cylinder at both tips or shape edges of the cylinder, creating back flow or eddies on both lateral sides. At the trailing edge C , the flow pattern changes according to the free stream Reynolds' number. At low Reynolds' number, the two divided streams create alternating vortices, shed downstream. At higher Reynolds' number, the two streams join together at alternating streamwise locations creating a turbulent wake downstream of the cylinder.

When the inclined front face of the cylinder AB makes an angle with the free stream, the flow separates at both A and B (the pattern is asymmetrical). The radius of curvature of the separated streamline at A , r_A , is smaller than the radius of curvature at B , r_B . As a result of conservation of angular momentum, the velocity at A is higher than at B ; therefore, the pressure at A is lower than at B ($P_A < P_B$). Hence, the cylinder rotates clockwise about the pivot, and the frontal surface AB becomes more aligned with the free stream.

With the continuous motion, the triangle will arrive at a position where AC is parallel to the free stream. The flow separates at the upper tip of the cylinder (B), but the flow in the lower part separates only at the lower tip of the cylinder (A), before reattaching to the lower lateral face (AC). The flow is then similar to that over a flat plate.

Because of the difference between the two flow patterns, the local pressures differ at the upper and lower parts of the cylinder. The upper part, with the existence of a large eddy, has lower pressure, compared with the free stream; whereas at the lower part the pressure is equal to the free stream pressure. The pressure in the lower part is now greater than the upper part, ($P_A > P_B$) and the cylinder tends to rotate back to its original position.

As a consequence of the above, the resultant pressure forces the cylinder to rotate counterclockwise back to its original position (under the assumption that the cylinder starts rotating in a clockwise direction, as described in the previous step). Due to the inertia of the cylinder, the motion does not stop when it returns to the original symmetric position as shown on the left side of figure 1. Instead, the cylinder continues to swing in the counterclockwise rotation. The flow pattern is as shown in figure 2.

The overall phenomenon can be viewed as the interchange of the flow patterns, from the flow past the sharp edge to flow over the flat plate, and vice versa.

Direct dye injection flow visualization

The flow was visualized using direct dye flow injection and particle image velocimetry (PIV). The experiment was conducted in the 45 cm x 45 cm x 100 cm water tunnel facility at Nanyang Technological University, Singapore. The free stream velocity, U_∞ was 7.5 cm/s. The cylinder was made from Delrin® plastic with density, $\rho = 1400 \text{ kg/m}^3$. The cylinder's width, W was 10 cm. This corresponds to Reynolds number, Re_W , of 7500 based on the cylinder's width. We put the plate at the end of the cylinder, such that, the flow surrounds this cylinder was essentially two-dimensional. The cylinder geometry and the experimental setup are shown in figure 3.

Firstly, direct dye injection technique was used to observe the flow pattern. The food coloring dye was released upstream of the cylinder. The images were captured by digital video camera as are shown in figures 4 and 5. The oscillation frequency, f was 0.13 Hz, observed from the recorded side-force (in cross-stream direction) measurement, corresponding to a Strouhal number ($St \equiv fW/U_\infty$) of 0.1733.

The overall phenomenon of the triangular cylinder oscillating in a to-and-fro manner can be clearly observed. As seen from the dye, there is an interchange of flow patterns from the flow over the flat plate (AC) to flow past sharp edge (A), resulting in a clockwise rotation of the cylinder. Because of inertia, the cylinder begins to swing in the counter clockwise rotation and the interchange of flow pattern from flow past sharp edge to flow over the flat plate is observed.

Particle Image Velocimetry.

Particle Image Velocimetry (PIV) measurements of the velocity field was conducted, with the same flow conditions as the previous direct dye injection experiment, i.e. $U_\infty = 7.5 \text{ cm/s}$, $Re_W = 7500$. The camera was put on the top of the water tunnel to capture the cylinder's side view flow image,

whereas the laser was to put at the side to create planar laser sheet. The setup is shown in figure 6. The 0.1 micron nylon particles for PIV were released upstream of the triangular cylinder, at a time synchronizes to the laser firing and camera capturing time.

Since, the oscillation frequency was consistently at 0.13 Hz ($St = 0.1733$), we could do phase-average PIV, i.e. capturing and processing the PIV images and data at the same angular position and the same rotational motion direction, but from different oscillation cycles.

Figure 7 shows the time-sequence PIV results when the cylinder moves in a counter-clockwise direction. The camera images are shown on the left and the corresponding velocity fields are on the right. Note that, in these plots, the free stream direction is from the right to left. In the top part of figure 7, the velocity vectors on the right side on the observed surface –marked in black are mostly uniform and attached to the cylinder's surface. In the middle part of figure 7, the cylinder moves and the fluid adjacent to the surface is moved by the cylinder. The velocity vectors appears to point upwards and to the left with the cylinder's counter-clockwise motion. In the bottom part of figure 7, the cylinder stops rotating. The flow separates from the sharp edges, creating reversed flow on the observed surface as indicated by the velocity vectors.

Overall, figure 7 shows the change of flow pattern from the flow-over-flat-plate-like on the observed surface (the top part of in figure 7) to the flow-past-sharp-edge-like (the bottom part of figure 7); in agreement with the dye flow visualization discussed in previous sections. When the cylinder moves in the clockwise direction similar agreement was observed.

Conclusions

At certain uniform incoming flow velocities, the equilateral triangular can oscillate continuously, under initial perturbation. This self-excited oscillation exists when the flow is two-dimensional and the Strouhal number of $0.13 < St < 0.18$. The recent results from direct dye injection flow visualization as well as Particle Image Velocimetry (PIV) supports the proposed explanation of the phenomena. Such motion arose from the resultant forces acting on the cylinder's side faces. On one side, the flow is similar to that flow over flat plate, whereas the other side, it is similar to that past a sharp edge. When the cylinder rotates, these mechanisms switch interchangeably, and cause the cylinder to oscillate incessantly.

References

1. Hu, C.C, Miao, J.J. and Chou, J.H., 2002. *Instantaneous Vortex-shedding Behaviour in Periodically Varying Flow*, Proceedings of Royal Society London A, Vol. 458, 911-932.
2. Nagashima, T. & Hirose, T, *Potential Flow around Two Dimensional Isosceles Triangular Cylinder Subjected to Uniform Flow from Base Surface*, Journal of Japan National Defense Agency.
3. Nakamura, Y. & Nakashima, M., 1986. *Vortex Excitation of Prisms with Elongated Rectangular, H and \perp Cross-sections*, Journal of Fluid Mechanics, Vol. 163, 149-169.
4. Naudascher, E. & Wang, Y., 1993. *Flow-induced Vibrations of Prismatic Bodies and Grids of Prisms*, Journal of Fluids and Structures, Vol. 7, 341-373.
5. Sakamoto, H., Takai, K., Alam, M.M. and Moriya, M., 2001. *Suppression and Characteristics of Flow Induced Vibration of Rectangular Prisms with Various Width-to-height Ratios*, in *Fluid Structure Interaction*, Chakrabarti, S.K & Brebbia, C.A. (eds.), WIT Press, 67-76.
6. Srigrarom, S, 1998. *Self-Excited Oscillation of Triangular Cylinder*, Master Thesis, Department of Aeronautics and Astronautics, University of Washington, Seattle, Washington, USA.
7. Srigrarom, S, 2003. *Self-Excited Oscillation of Equilateral Triangular Cylinder*, Proceedings of the IUTAM Symposium on Fluid-Structure Interactions, New Brunswick, New Jersey, USA, June 2-6, 2003, Vol.1.

Figures

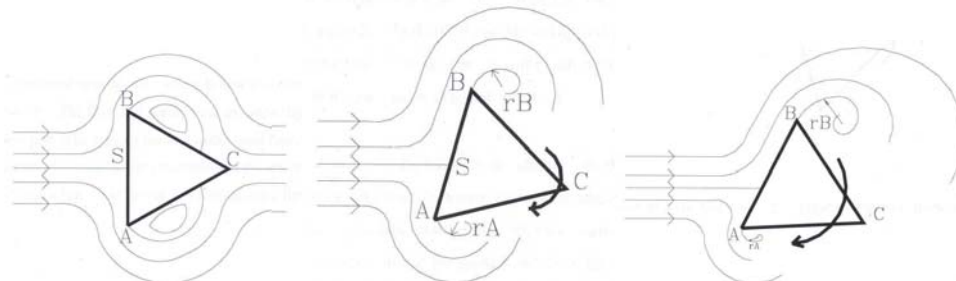

Fig. 1: Sequence of flow past the equilateral triangular cylinder, rotating in clockwise direction

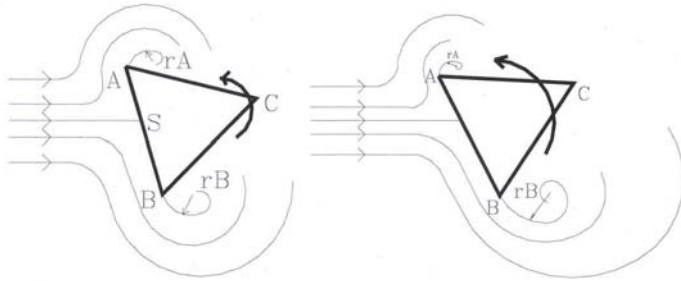

Fig. 2: Sequence of flow past the equilateral triangular cylinder, rotating in counter-clockwise direction

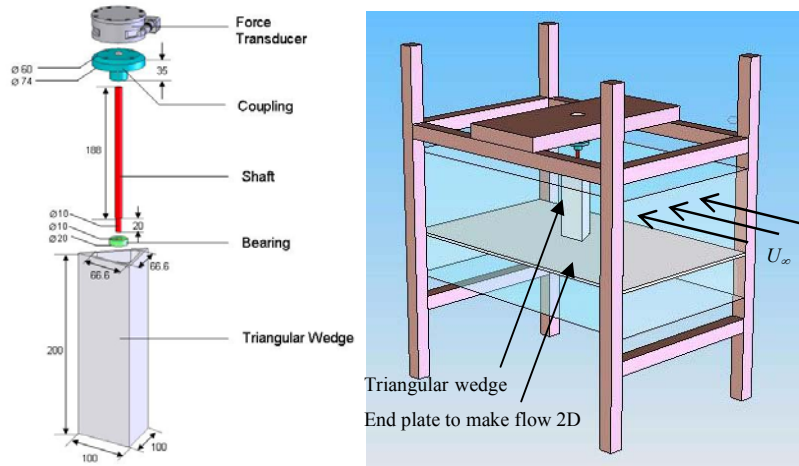

Fig. 3: The geometry of the cylinder (wedge), with the built-in bearings and the mounted force transducer. (left). All dimensions are in millimeters (mm). Experimental setup (only the test section in the water tunnel shown) (right).

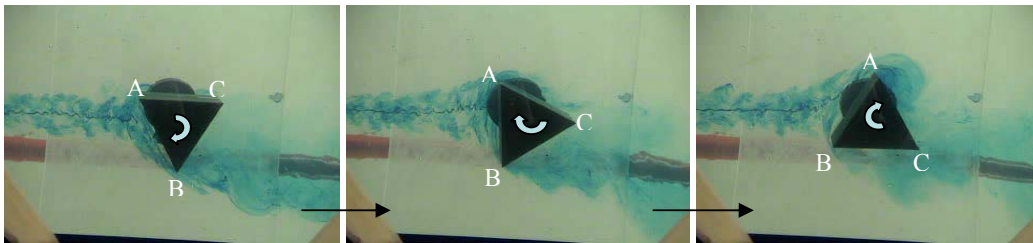

Fig. 4: Cylinder's oscillation in clockwise motion

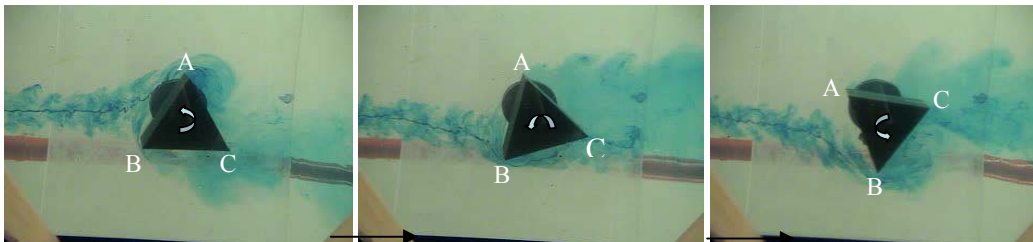

Fig. 5: Cylinders' oscillation in counter-clockwise motion

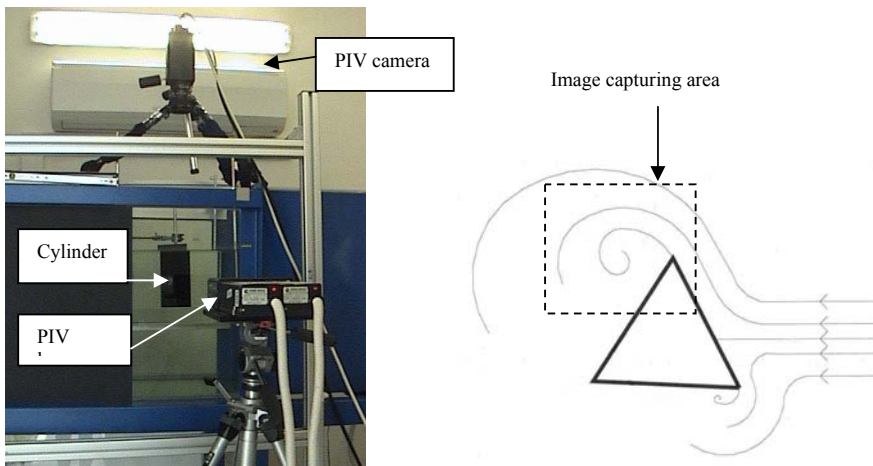

Fig. 6: Experiment setup for Particle Image Velocimetry (left) and image capturing area (right)

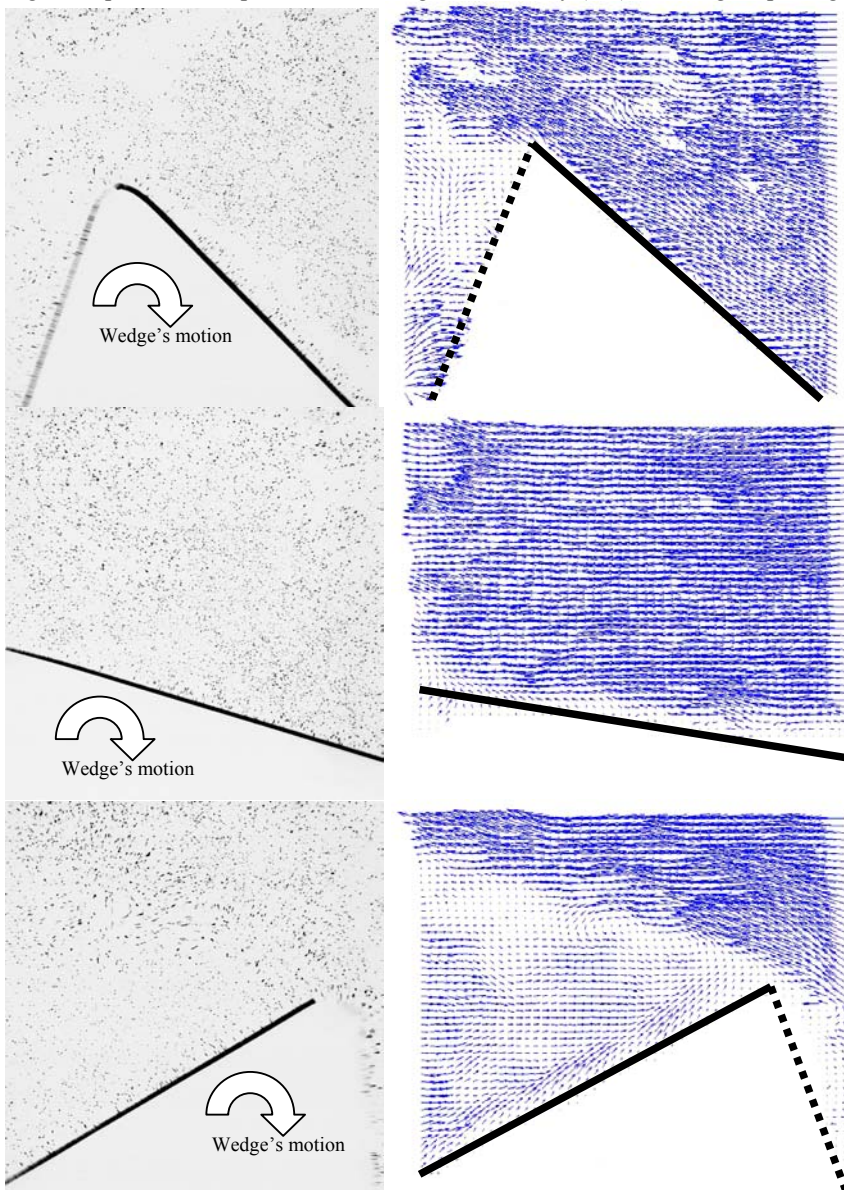

Fig. 7: Sequence of captured camera images (left) and the corresponding velocity fields (right), when the cylinder was swinging against the flow (clockwise motion).